

# RVH8584

UNDERMOUNT SLOPE BOTTOM SINK

# RUVATI®

SPECIFICATION SHEET

## MATERIAL

True 16 Gauge Thickness  
Premium T304 Grade Stainless Steel  
18/10 Chromium/Nickel Content  
Commercial Brushed Finish

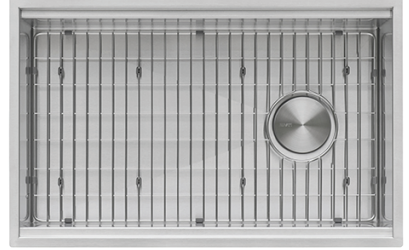

## FEATURES

- Heavy duty sound guard padding and undercoating
- Slanted bottom with elegant drain grooves for easy draining
- Reversible Offset Drain with Sloped Bottom



## IN THE BOX



Basket Strainer  
[RVA1025]

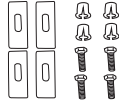

Mounting Clips  
[RVA11031]



Drain Cover  
[RVA1035]

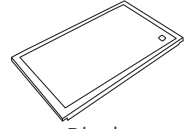

Black  
Cutting Board  
[RVA1217BWC]



Cut-out  
Template

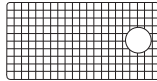

Rinse Grid  
[RVA68582]

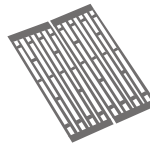

Folding Rack  
[RVA1397]

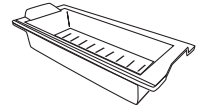

Colander  
[RVA1637BLK]

## NOMINAL DIMENSIONS

Exterior: 30" (wide) x 19" (front-to-back)  
Interior Bowl: 28-3/8" (wide) x 16" (front-to-back)  
Bowl Depth: 10"  
Minimum Cabinet Size: 33" wide  
Drain Hole Size: 3 1/2"

Installation Type:  
Undermount

Inside Corners:  
Rounded

Drain Location:  
Offset

# RUVATI USA

www.ruvati.com

Phone: 1.855.478.8284  
Email: support@ruvati.com

# OPTIONAL ACCESSORIES (SOLD SEPARATELY)



Deep Basket  
Disposal Flange  
[RVA1049ST]

## DIMENSIONS

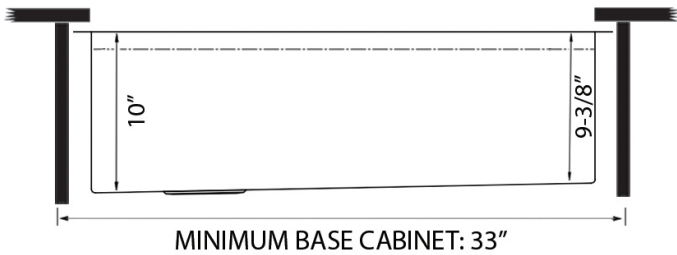
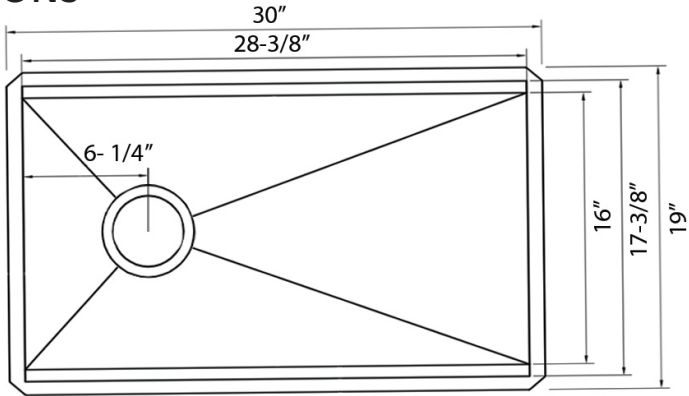

Register your product at [www.ruvati.com/register](http://www.ruvati.com/register).